

Feature Specifications – Energos Control System (For standard Energos fixtures consult appropriate EG spec sheets)

Feature Specifications

Electrical

Dedicated low voltage (24 VDC) circuit controls the Energos Control Systems. The line voltage circuits control all the standard ballast functions including A/B switching, Dimming and Emergency Battery Pack operations.



1. End Cap Sensor Mounting



2. Mid-mounted 8' (243.84cm) Sensor Mounting

ECS occupancy sensors are available in two variations:

- Mounted in the end cap.
- The middle of an 8' (243.84cm) module.

The ECS system control-center is the Power Pack. The Power Pack, contained in each Master Module, interrupts the circuits when parameters dictate. The Power Pack can control up to 600 watts 120 VAC, and 1300 watts 277 VAC. A maximum of 10 sensors can be used on a single Power Pack. There is no limitation to the number of Power Packs that can be "daisy-chained" to a single ECS circuit.

Emergency battery packs can be used in conjunction with ECS for emergency egress lighting since all listed packs operate for a minimum of 90 minutes. EM Packs can be used as momentary lighting for emergency circuit for power transitions, and smaller packs are recommended for this purpose.

Dimming ballasts can be used in conjunction with ECS. However, the control system will only perform ON or OFF operations and will not affect the level of dimming set by the dimming ballasts.

Factory installed ballast disconnect allows the ballast to be disconnected from and reconnected to incoming power under load without turning the entire circuit off.

Serial Row Linking (SRL) provides multiple continuous row communication. For every run that SRL is required, order the appropriate SRL end set from page 2 of this Specification Sheet. Consult Energos Application Guide for more detailed definitions and examples.

Mountings

Cable suspension distances are on 48" (121.92cm) and 96" (243.84cm) centers, and consist of a 4 1/2" (11.43cm) diameter canopy finished white enamel. A 1/16" (0.16cm) diameter stainless steel aircraft cable accomplishes suspension and is adjustable from 12" (30.48cm) to 36" (91.44cm). Power feeds are 18 gauge white cord.

Occupancy Sensors:

- Time delay is factory pre-set to 30 minutes.
- Time delay can be field adjusted from 30 minutes to a minimum of 30 seconds.
- Daylight hold-off is factory pre-set to 120 ft-candles (1291.67m-candles).
- Daylight hold-off is field adjustable from 120 ft-candles (1291.67m-candles) down to 10 ft-candles (107.64m-candles).
- Sensors are designed for a detection area (sensitivity diameter) of 16' (487.68cm) when suspended 10' (304.80cm) AFF. Lowering the sensor produces a smaller area of detection. See chart and diagram for additional information.
- Wattstopper FS-205v2

Coverage Diameter

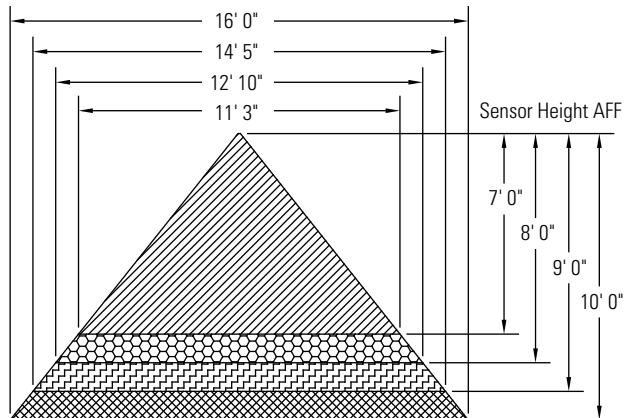

Energos Occupancy Sensor Coverage Zone Chart

Height of Sensor	Broadcast Diameter	Task Diameter
10' 0" (304.80cm)	16' 0" (487.68cm)	8' 0" (243.84cm)
9' 0" (274.32cm)	14' 5" (427.99cm)	7' 3" (214.12cm)
8' 0" (243.84cm)	12' 10" (391.16cm)	6' 5" (184.15cm)
7' 0" (213.36cm)	11' 3" (336.04cm)	5' 7" (154.18cm)

Job Information	Type:
Job Name:	
Cat. No.:	
Lamp(s):	
Notes:	

Control Ordering Information

Family	Series	Lamping & Distribution	Ballast	Lamp	Shielding	Length	Voltage	Finish	Options (Blank)
EC	1	<p>1 = 1 lamp, open top</p> <p>4 = 1 lamp, slotted top reflector</p>	See Chart on Page 3	See Chart on Page 3	P = Parabolic Louver	<p>4 = 4' (121.92cm)</p> <p>8 = 8' (243.84cm)</p>	<p>6 = 120 Vac Master</p> <p>7 = 277 Vac Master</p> <p>8 = 120 Vac Slave</p> <p>9 = 277 Vac Slave</p>	<p>A = Aluminum</p> <p>W = White</p>	<p>4 = 4 through wires</p> <p>5 = 5 through wires</p> <p>6 = 6 through wires</p> <p>D = Dual Switch</p> <p>T = Tandem Switch</p> <p>E = Emergency</p>

Ordering Instructions

End Cap ECS Systems

- Order Master 4' (121.92cm) or 8' (243.84cm) ECS Module.
- Order Power Feed End Set.

Continuous Row Mounted ECS Systems:

- Determine run length
- Order a minimum of one master per run. Please see Application Guide for master requirements on runs that exceed 16' (487.68cm).
- Order the required remaining Master and Slave modules to complete the run.
- Order Power Feed End Set.
- Order one CABLE ASSEMBLY per MODULE minus one per run.
- Order additional Single Cable & Cord Sets for every Master Module in run.

ECS Sensor Sample Runs



4' Run: 4' (121.92cm) Master Module with Single Sensor End Set.



8' Run: 8' (243.84cm) Master Module and standard Energos End Set.



8' Run: 8' (243.84cm) Master Module and Dual Sensor End Set.



12' Run: 8' (243.84cm) Master Module, 4' (121.92cm) Slave Module, Dual Sensor End Set, and Intermediate Cable Assembly.

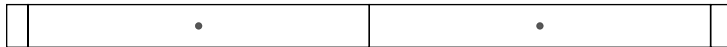

16' Run: 8' (243.84cm) Master Module, 8' (243.84cm) Slave Module, standard Energos End Set, and Intermediate Cable Assembly.

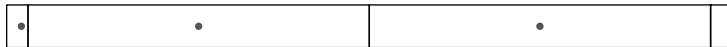

16' Run: 8' (243.84cm) Master Module, 8' (243.84cm) Slave Module, Single Sensor End Set, and Intermediate Cable Assembly.

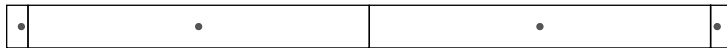

16' Run: 8' (243.84cm) Master Module, 8' (243.84cm) Slave Module, Single Sensor End Set, and Intermediate Cable Assembly.

Notes:

- See page 1 of Specification Sheet or consult Application Guide for the definition of Serial Row Linking (SRL).
- Consult the matching EG specification sheet for Luminaire related specifications (i.e. Housing materials, shielding, mounting dimensions, and photometry).

ECS End Sets



Single Sensor End Set EC1SE36W



Dual Sensor End Set EC1DE36W



Single Cable & Power Cord EGCC36

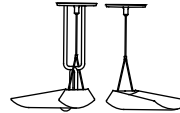

Single Sensor SRL End Set EC1SR36W

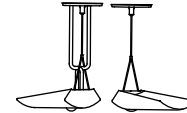

Dual Sensor SRL End Set EC1DR36W



Standard End Set EG1EC36W

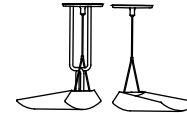

SRL Standard End Set EC1ER36W

Job Information

Type:

Ballast Ordering Information

Design	Lamp Type	Ballast Factor	Start Type	THD %
D	T8	0.71	Program	<10
E	T8	0.88	Program	<10
H	Dim T8	1.00/.05	Program	<10

Lamp Ordering Information

Design	Lamp Type	Wattage	Rated Output (Lumens)	Color (K)
A	T8	28	2725	3000
B	T8	28	2725	3500
C	T8	28	2725	4100
D	T8	30	2850	3000
E	T8	30	2850	3500
F	T8	30	2850	4100
G	T8	32	3000	3000
H	T8	32	3000	3500
I	T8	32	3000	4100
J	T8	32	3100	3000
K	T8	32	3100	3500
L	T8	32	3150	4100

Lamp and Ballast System Data

Design	Lamp Type (T8 or T5)	Ballast Factor (BF)	Ballast THD (%)	Lamp Rated Wattage	Lamp Rated Output	Lamp Color (Kelvin)	IES Output (lumens)	System Input Watts	System Efficacy (lum/watt)	System Lamp Life (Hours)	Start Type
DA	T8	0.71	<10	28	2725	3000	2199	20.0	96.74	24000	Program
DB	T8	0.71	<10	28	2725	3500	2199	20.0	96.74	24000	Program
DC	T8	0.71	<10	28	2725	4100	2199	20.0	96.74	24000	Program
DD	T8	0.71	<10	30	2850	3000	2299	21.5	94.12	24000	Program
DE	T8	0.71	<10	30	2850	3500	2299	21.5	94.12	24000	Program
DF	T8	0.71	<10	30	2850	4100	2299	21.5	94.12	24000	Program
DG	T8	0.71	<10	32	3000	3000	2420	23.0	92.61	24000	Program
DH	T8	0.71	<10	32	3000	3500	2420	23.0	92.61	24000	Program
DI	T8	0.71	<10	32	3000	4100	2420	23.0	92.61	24000	Program
DJ	T8	0.71	<10	32	3100	3000	2501	23.0	95.70	30000	Program
DK	T8	0.71	<10	32	3100	3500	2501	23.0	95.70	30000	Program
DL	T8	0.71	<10	32	3150	4100	2541	23.0	97.24	30000	Program
EA	T8	0.88	<10	28	2725	3000	2725	25.5	94.04	24000	Program
EB	T8	0.88	<10	28	2725	3500	2725	25.5	94.04	24000	Program
EC	T8	0.88	<10	28	2725	4100	2725	25.5	94.04	24000	Program
ED	T8	0.88	<10	30	2850	3000	2850	27.5	91.20	24000	Program
EE	T8	0.88	<10	30	2850	3500	2850	27.5	91.20	24000	Program
EF	T8	0.88	<10	30	2850	4100	2850	27.5	91.20	24000	Program
EG	T8	0.88	<10	32	3000	3000	3000	29.0	91.03	24000	Program
EH	T8	0.88	<10	32	3000	3500	3000	29.0	91.03	24000	Program
EI	T8	0.88	<10	32	3000	4100	3000	29.0	91.03	24000	Program
EJ	T8	0.88	<10	32	3100	3000	3100	29.0	94.07	24000	Program
EK	T8	0.88	<10	32	3100	3500	3100	29.0	94.07	24000	Program
EL	T8	0.88	<10	32	3150	4100	3150	29.0	95.59	24000	Program
HG	T8 DIM	1.0 / 0.5	<10	32	2850	3000	2850 / 143	34 / 8	83.80	NA	Program
HH	T8 DIM	1.0 / 0.5	<10	32	2850	3500	2850 / 143	34 / 8	83.80	NA	Program
HI	T8 DIM	1.0 / 0.5	<10	32	2850	4100	2850 / 143	34 / 8	83.80	NA	Program

*25°C Rating

All data is per 1 lamp on a two lamp system at 277 VAC.

Data is based on Osram Sylvania specifications.

When ordering no lamps provided by Lightolier, use lamp code "Z".

The lumen value for the lamp (within a Lighting Design program) will be the IES Output value shown on this table.

The lamp life table demonstrates the effects of shortened cycle-times with both program start and instant start ballasts. The graph shows that instant ballasts are susceptible to shortened lamp life if short cycle periods of less than 3 hours are used. For cycle periods of greater than 3 hours program start ballast are not required.

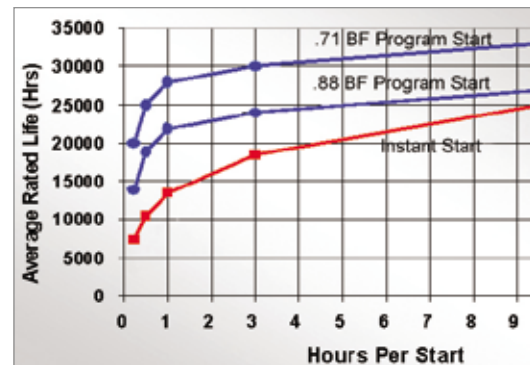

Lamp Life Table using program start and instant start ballasts.

Job Information Type: