

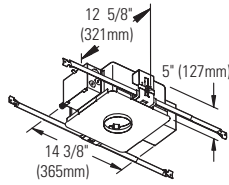

Non-IC Frame:

- C3LV**
- C3LVE1**
- C3LVE2**



Non-IC AirSeal Frame:

- C3ALV**
- C3ALVE1**
- C3ALVE2**

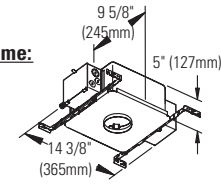

IC AirSeal Frame:

- C3AICLV**
- C3AICLVE1**

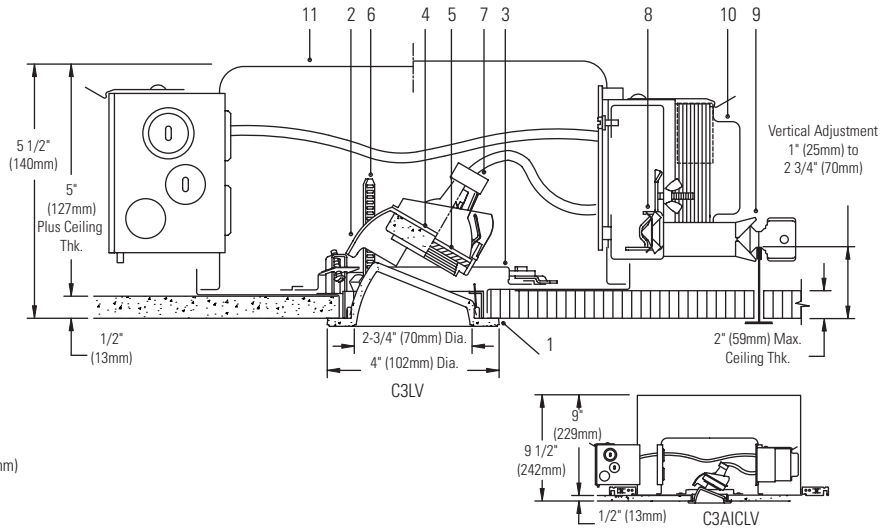
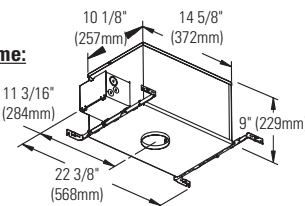

Ceiling Cutout: 3 1/2" (130mm) Dia. **For Complete Fixture Order:** Trim Kit + Frame-In Kit. Each Sold Separately.

Trim Kit	Frame-In Kit	Lamp*
Etch White Glasslite C3MRGA	C3LV Non-IC Magnetic 120/277V 42W-65W MR16 (12V)	
	C3LVE1 Non-IC Electronic 120V 20W-65W MR16 (12V)	
	C3LVE2 Non-IC Electronic 277V 20W-65W MR16 (12V)	
	C3ALV Non-IC AirSeal® Magnetic 120/277V 42W-65W MR16 (12V)	
	C3ALVE1 Non-IC AirSeal® Electronic 120V 20W-65W MR16 (12V)	
	C3ALVE2 Non-IC AirSeal® Electronic 277V 20W-65W MR16 (12V)	
	C3AICLV IC AirSeal® Magnetic 120 20W-50W MR16 (12V)	
	C3AICLVE1 IC AirSeal® Electronic 120V 20W-50W MR16 (12V)	

Note: Magnetic not recommended for residential or noise sensitive areas.

Features

- Glasslite:** One piece borosilicate glass with integral flange, etched interior and white ceramic coated exterior. Etched white cone finish emits a subtle glow. Hinged, and snaps on for easy tool-less installation. Interchangeable with other 3" Evolution trims. Suitable for shower and other wet environments.
- Trim Kit Vertical Adjustment Mechanism:** Die-cast aluminum. Built-in aperture shield blocks view into fixture. Provides 0°- 45° vertical tilt up to 1" thick ceiling, less in thicker ceilings; lockable. 30° maximum tilt in ceilings 1.25"- 2" thick. EZ-Aim Helical Drive System provides fast and accurate hot aiming with Philips screwdriver.
- Horizontal Adjustment Mechanism:** Die-form steel ring, matte black finish. Provides 362° horizontal stop, lockable with Philips screwdriver.
- Lamp Support:** Die-form aluminum with knurled surface for easy gripping during relamping. Spring tension clips hold lamp and lens and allow fast snap-in, snap-out relamping. Matte black finish. Accepts up to two 2" diameter accessories.
- Cover Glass:** High temperature, clear lens.
- Thick Ceiling Ready Brackets:** Die-form steel, matte black finish. Adjust trim kit vertically to accommodate up to 2" thick ceiling, lockable.
- Lampholder:** Procelain bi-pin socket. Pre-wired with No.18 AWG Teflon leads.
- Frame Vertical Adjustment Mechanism (C3LV):** Accommodates mounting to virtually any ceiling system using pre-installed mounting bars, or 1/2" EMT tubing (by others). Single locking features secures all adjustments. Alignment holes and markings allow fixture to be pre-set prior to installation. Final adjustment can be made from below inside fixture.
- Mounting Bars (C3LV):** Galvanized steel, 0.048"; pre-installed telescoping bars extend from 20" to 30" long and lock securely into position. Built-in locking tabs provide positive attachment to common T-bar systems. Self-centering feature simplified installation in 24" O.C. grid systems. Attaches to steel or wood joists without accessories.
- Transformer:** Replaceable from below. Magnetic: 120V/277V 60 Hz. dual-voltage, core & coil. **Note:** Magnetic not recommended for residential or noise sensitive areas. Electronic: 120V or 277V 50/60 Hz., regulated lamp voltage, HPF, EMI and circuit protections, thermal auto-reset, quiet operation.

Features (cont.)

- Frame-In Kit:** See Frame-In Kit specification sheets for more information.
 - Non-IC and Non-IC AirSeal - Insulation must be kept 3" away from any parts of the luminaire and must not be placed above luminaire in a manner which will entrap heat.
 - IC AirSeal - Luminaire may be in direct contact with thermal insulation.

Labels

U.L. (Suitable For Wet Locations), I.B.E.W.

*Lamp wattage restriction for Non-IC: 65W for up to 1" thick ceiling, 50W for ceiling thickness greater than 1" (up to 2").

Options and Accessories

2" dia. Color Filters/Specialty filters: See ADF2/AF2 specification sheets

2" Dia. Louver: AL2HC

Chicago Plenum: Consult Factory

Job Information	Type:
Job Name:	
Cat. No.:	
Lamp(s):	
Notes:	

Lightolier a Genlyte company www.lightolier.com
 631 Airport Road, Fall River, MA 02720 • (508) 679-8131 • Fax (508) 674-4710
 We reserve the right to change details of design, materials and finish.
 © 2011 Genlyte Group LLC • F0711



(FC) is initial footcandles at center of beam. Beam length (L) and beam width (W) are to where the candlepower is reduced to 50% of the center beam candlepower. (C) is the distance to the center of the beam. Footcandles are based on photometry with luminaire, with lamp aimed at 30° from vertical.

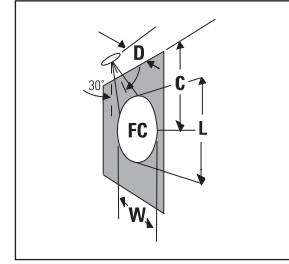
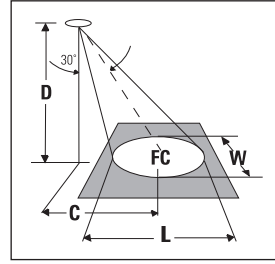

CANDLEPOWER DISTRIBUTION

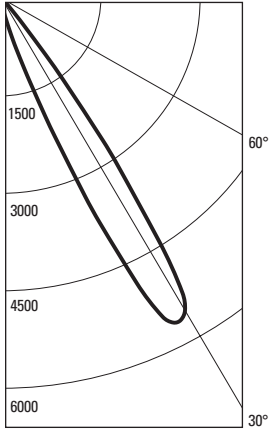

50W MR16 (12V) 15° Spot

ANGLE	WALL	AIMED 30° TOWARD WALL
0	93	
5	133	GE HALOGEN LAMP
10	249	120V ELECTRONIC TRANSFORMER
15	668	LUMEN RATING = 750 LMS
20	1938	CBCP= 5625 cd
25	4839	BEAM ANGLE = 13°
30	5544	
35	2667	CERTIFIED TEST REPORT NO. 2711FR
40	347	DATE: Aug 29, 2004
45	67	**TEST-LITE**
50	47	
55	22	
60	14	
65	10	
70	8	
75	8	
80	6	
85	4	
90	2	

**30° Aiming Angle
Horizontal Surface**

D	C	FC	L	W
6'	3.5'	107	1.8'	1.6'
8'	4.6'	61	2.4'	2.1'
10'	5.8'	39	3.1'	2.6'
12'	6.9'	27	3.7'	3.2'
15'	8.7'	18	4.6'	3.9'

**30° Aiming Angle
Vertical Surface**

D	C	FC	L	W
2'	3.5'	235	1.9'	0.9'
3'	5.2'	106	2.8'	1.4'
4'	6.9'	60	3.8'	1.8'
6'	10.4'	27	5.7'	2.7'
8'	13.9'	15	7.6'	3.6'

CANDLEPOWER DISTRIBUTION

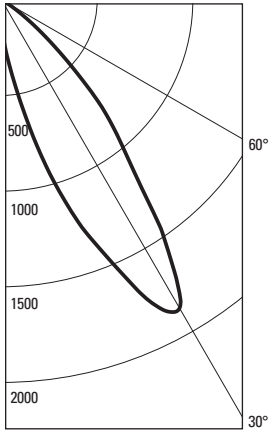

50W MR16 (12V) 25° Narrow Flood

ANGLE	WALL	AIMED 30° TOWARD WALL
0	147	
5	273	GE HALOGEN LAMP
10	508	120V ELECTRONIC TRANSFORMER
15	899	LUMEN RATING = 800 LMS
20	1297	CBCP= 1861 cd
25	1668	BEAM ANGLE = 25°
30	1861	
35	1440	CERTIFIED TEST REPORT NO. 2707FR
40	964	DATE: Aug 29, 2004
45	615	**TEST-LITE**
50	300	
55	107	
60	15	
65	10	
70	9	
75	7	
80	5	
85	3	
90	3	

**30° Aiming Angle
Horizontal Surface**

D	C	FC	L	W
6'	3.5'	35	3.6'	3.1'
8'	4.6'	20	4.8'	4.1'
10'	5.8'	13	6.0'	5.1'
12'	6.9'	9	7.2'	6.1'
15'	8.7'	6	9.0'	7.7'

**30° Aiming Angle
Vertical Surface**

D	C	FC	L	W
2'	3.5'	75	4.2'	1.8'
3'	5.2'	33	6.2'	2.7'
4'	6.9'	19	8.3'	3.5'
6'	10.4'	8	12.5'	5.3'
8'	13.9'	5	16.6'	7.1'

CANDLEPOWER DISTRIBUTION

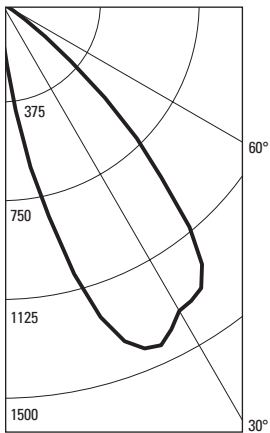

50W MR16 (12V) 40° Flood

ANGLE	WALL	AIMED 30° TOWARD WALL
0	109	
5	235	GE HALOGEN LAMP
10	633	120V ELECTRONIC TRANSFORMER
15	1065	LUMEN RATING = 800 LMS
20	1366	CBCP= 1433 cd
25	1433	BEAM ANGLE = 34°
30	1349	120V ELECTRONIC TRANSFORMER
35	1321	
40	1110	CERTIFIED TEST REPORT NO. 2710FR
45	726	DATE: Aug 29, 2004
50	344	**TEST-LITE**
55	110	
60	15	
65	9	
70	7	
75	5	
80	5	
85	3	
90	3	

**30° Aiming Angle
Horizontal Surface**

D	C	FC	L	W
6'	3.5'	31	5.0'	4.2'
8'	4.6'	18	6.7'	5.6'
10'	5.8'	11	8.4'	7.1'
12'	6.9'	8	10.1'	8.5'
15'	8.7'	5	12.6'	10.6'

**30° Aiming Angle
Vertical Surface**

D	C	FC	L	W
2'	3.5'	79	6.8'	2.4'
3'	5.2'	36	10.2'	3.7'
4'	6.9'	20	13.6'	4.9'
6'	10.4'	9	20.4'	7.3'
8'	13.9'	5	27.2'	9.8'

Job Information **Type:**

Lightolier a Genlyte company www.lightolier.com
 631 Airport Road, Fall River, MA 02720 • (508) 679-8131 • Fax (508) 674-4710
 We reserve the right to change details of design, materials and finish.
 © 2011 Genlyte Group LLC • F0711