

Calculite 1.75" Aperture, 400 Lumen LED

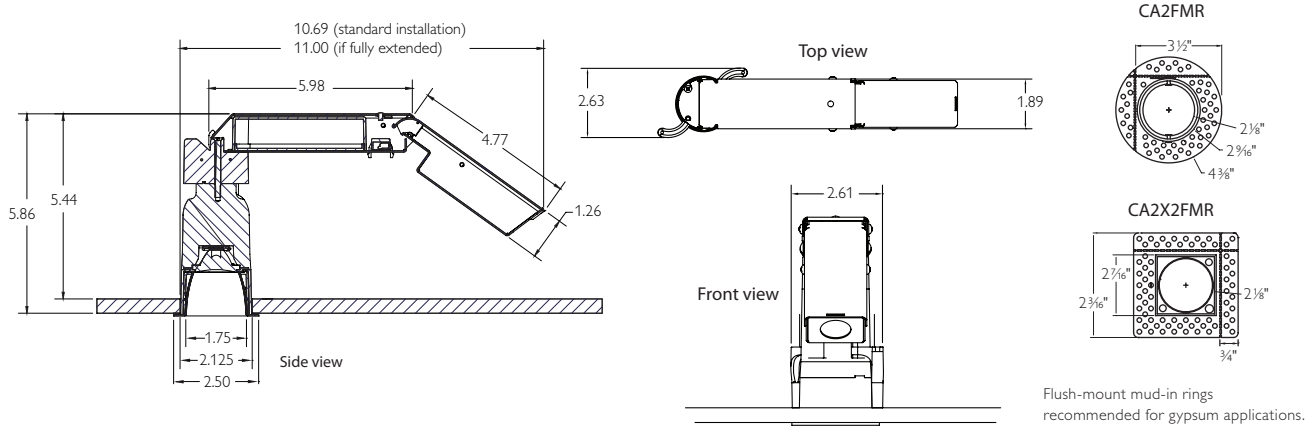

Ordering Guide: Frame-in Kits

Frame-in Kit Series	Lumen Package (nominal)	Style	Color Temp	Beam Spread	Installation Style ²	Input Voltage
C2L	04 (400 Lumens)	DL (Downlight flanged)	30K (3000K)	12 (12 degrees)	R (install-from-below)	1 (120V) UZ10V (universal with 0-10V dimming)
		DLFT (Downlight flush-mount) ¹	27K (3000K)	17 (17 degrees)		
				25 (25 degrees)		
				38 (38 degrees)		
				47 (47 degrees)		

¹requires "FT" series reflectors

Ordering Guide: Reflectors

Reflector Series	Style	Finish	Flange
C2L (Round)	DL (Downlight-50° cutoff)	BK (Black)	P (aperture-matching)
	DLLS (Downlight with linear spread lens-75° cutoff)	CCD (Comfort Clear Diffuse)	FT (Flush mount)*
	LW (Lensed Wall Washer) ^{3,4}	CCZ (Champagne Bronze)	
C2X2L (Square)	DL (Downlight-50° cutoff)	WH (Painted White)	
	LW (Lensed Wall Washer) ³	BK (Black)	P (Aperture-matching)
		WH (Painted White)	FT (Flush-mount)*

*requires "FT" series frame-in kit

³17° beam spread recommended
⁴18" max installation from vertical surface recommended

Job Information	Type:
Job Name:	
Cat. No.:	
Notes:	

Calculite 1.75" Aperture, 400 Lumen LED

Features

Aperture: 1.75" (44 mm) I.D., 2.50" (63mm) O.D.

Input Wattage: 11W max. (C2L04)

Fixture Output: Aluminum. Provides 50° cutoff to source & source image. Self-flanged.

Beam Spread options:

Beam Spread	Spacing Criterion	Delivered Lumens	Efficacy	CBCP
12°	0.2	328 lm	29.8 lm/w	5099
17°	0.3	412 lm	37.3 lm/w	3282
25°	0.4	382 lm	36.0 lm/w	1995
38°	0.6	377 lm	34.9 lm/w	936
47°	0.7	331 lm	30.0 lm/w	544

Reflector Cone: Aluminum. Provides 50° cutoff to source & source image. Twist & lock installation within frame-in kit ensures snug fit to ceiling.

Reflector Flange: Thickness: 0.09" (2.4 mm). Width (flanged) 0.37" (9.5 mm). Width "flush-mount) 0.19" (4.8 mm)

Required Depth: 5.91" (150 mm). 5.5" plenum depth required for Non-IC installation. see above for fixture dimensions

Ceiling Cutout: 2.125" (54mm)

Installation: Hinged design allows fixture to be installed from below ceiling. Two screws actuate pivoting installation arms. Vertical installation only (as shown in above drawings).

Thick Ceiling Capability: 3/8" - 2".

Optical Accessories: One (1) accessory as defined in "Accessories-Optical" below. Accessories install securely to top of reflector housing. Proper positioning ensured via offset die cut.

Field Accessibility: LED array, beam spreads (optics) and driver are field interchangeable/replaceable

Fixture Weight: 1.8 Lbs.

Electrical

Power connection: Integral connection between driver and LED array

Junction Box: UL listed for 6 No 12 AWG, 90°C through branch circuit connectors. Allows inspection from below. Compatible with 2-1 conduit connector for daisy chaining.

Minimum Starting Temperature: -20°C

Maximum Operating Temperature: 60°C

Input Voltage: 120V

Input Frequency: 60Hz

Input Current: .09A

LED Drive Current: 670mA

Input Power: 11W **LED Power:** 9.1W

THD: <20% **Power Factor:** >0.9

FCC Rating: Part 15 / Class B driver

Technology

Array: 4-chip LED array featuring 2-step SDCM binning control

Photometric Performance: Tested in accordance to IESNA LM-79-2008

Color Consistency: 2 SDCM (max.)

Spectral Power Distribution:

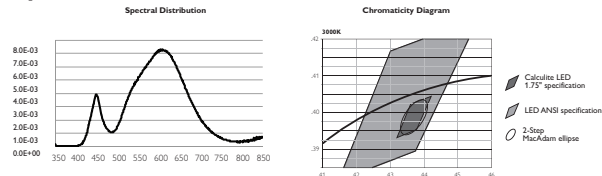

Color Rendering Index: 80 min, 82 typical

Ra	R1	R2	R3	R4	R5	R6	R7	R8	R9
81.0	80.2	87.1	91.0	78.9	78.3	81.0	85.6	66.2	21.3
R10	R11	R12	R13	R14					
67.7	74.9	62.1	81.4	94.2					

Dimming Capability: ELV dims to nominal 10% lumen output. See LED-DIM specification sheet for dimming system compatibility.

Emergency Capability (Inverter): Yes.

See LED-LMI specification sheet

Rated Life

LED Array: 50,000 hours at 70% lumen maintenance (L70, B50). Based on IESNA LM-80-2008.

Driver: 50,000 hours

Labels

UL, cUL, I.B.E.W, AirSeal

17°, 25° & 38° & 58° beams suitable for wet location

12° beam suitable for damp location

5 year warranty

Job Information	Type:
-----------------	-------

PHILIPS
LIGHTOLIER

Calculite 1.75" Aperture, 400 Lumen LED

Ordering Guide: Accessories

Accessories-Optical	Lumen Package (nominal)
CA2DF2	2 degree clear diffusion film*
CA2DF85	85 degree frosted diffusion film*
CA2OPF	Opal 2700K warming / frosted diffusion film*
	* actual diffusion depends on selected beam spread

To minimize accessory thickness and thus maximize optical performance, microstructure lenses are utilized in lieu of traditional glass lenses.

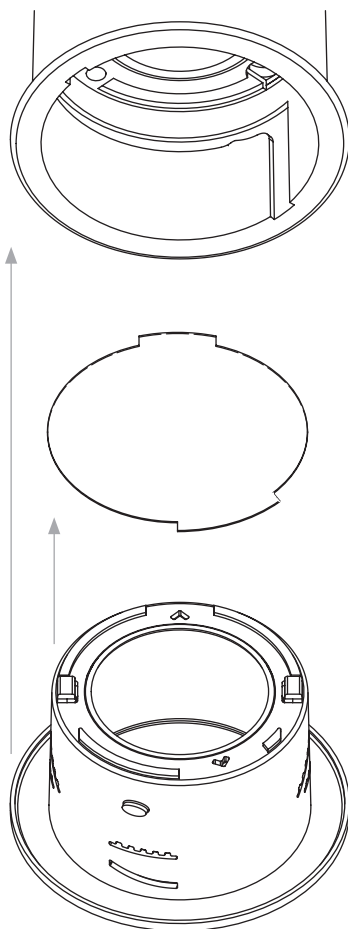

Reflector can be rotated 90° to ensure proper alignment. Friction-fit design maintains installation integrity.

For wall washer & linear spread options, lenses are factory-assembled into specified reflector.

Accessories are keyed to ensure proper installation.

Fixtures accept one accessory, which can be field-installed in any reflector assembly.

Durability

Calculite LED 1.75" fixtures operating temperatures are well below the recommended thermal limit of each optical accessory, eliminating lens degradation and ensuring maximum optical stability.

Job Information Type:

Calculite 1.75" Aperture, 400 Lumen LED

Optional Installation Accessories

The standard C2L product offering is Non-IC, wet location listed* with no additional "frame-in kit" required. Listed below are additional frame options.

C2LIC

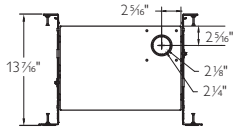

IC frame (new construction). Certified for use in Chicago Plenum applications. Includes bar hangers with preset screws which accommodate 12"-24" joist spacing. Bars also attach to T-bar ceilings. Width (min): 13 7/16", Length: 14 9/16", Depth: 9 5/16".

C2LMP

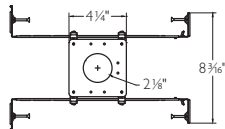

New construction mounting pan provides ability to prelocate wiring for easy below-ceiling access. Includes bar hangers with preset screws which accommodate 12"-24" joist spacing. Bars also attach to T-bar ceilings. Width: 5.5", Length (min): 13.12"

CA2FMR

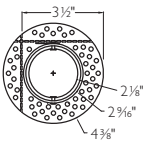

Round aperture flush-mount mud-in ring. Recommended for gypsum applications. Perforated flange allows installation only 1.4" from vertical structure, including corners.

CA2X2FMR

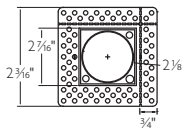

Square aperture flush-mount mud-in ring. Recommended for gypsum applications. Perforated flange allows installation only 1.4" from vertical structure, including corners. Square plate secures magnetically to mud-in ring. Tether included.

Ordering Guide: Installation Accessories

Accessories-Installation	Lumen Package (nominal)
CA2FMR CA2X2FMR C2LIC C2LMP	Round aperture flush-mount mud-in ring* Square aperture flush-mount mud-in ring* IC frame (new construction)* New construction mounting pan* * Recommended for specific applications.

Job Information Type:

Calculite 1.75" Aperture, 400 Lumen LED

Reflector Finish Multipliers: CCD (1.0) WH (0.95) CCZ (0.88 (est.)) BK (tbd) CCD finish is tested. All other finishes calculated.

Fixture: C2L04DL30K12R1
Reflector: C2LDLCCDP
Accessory: none
Beam Angle: 12°
Spacing Ratio: 0.2
CBCP: 5099
Lumens: 328
Watts: 11
Efficacy (lm/w): 29.8
CCT: 2990
Cutoff: 50°

Single Unit Data		
Ceiling Height	Initial Footcandles	Beam Diameter
5'	204	1.0'
6'	142	1.2'
7'	104	1.4'
8'	80	1.6'
9'	63	1.8'

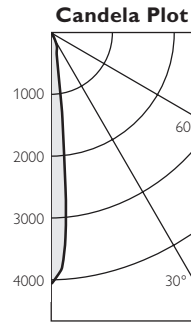

Candela Table		
Angle	Intensity	Lumens
0	5099	
5	2829	118
15	290	83
25	61	45
35	14	9
45	7	6
55	3	3
65	1	1

Fixture: C2L04DL30K17R1
Reflector: C2LDLCCDP
Accessory: none
Beam Angle: 17°
Spacing Ratio: 0.3
CBCP: 3282
Lumens: 412
Watts: 11
Efficacy (lm/w): 37.3
CCT: 2979
Cutoff: 50°

Single Unit Data		
Ceiling Height	Initial Footcandles	Beam Diameter
5'	131	1.5'
6'	91	1.8'
7'	67	2.1'
8'	51	2.4'
9'	41	2.7'

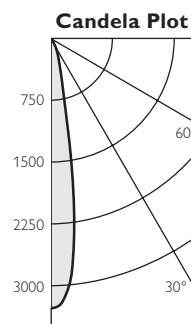

Candela Table		
Angle	Intensity	Lumens
0	3282	
5	2835	212
15	432	133
25	126	56
35	13	9
45	3	2
55	0	0
65	0	0

Fixture: C2L04DL30K25R1
Reflector: C2LDLCCDP
Accessory: none
Beam Angle: 25°
Spacing Ratio: 0.4
CBCP: 1995
Lumens: 382
Watts: 10.6
Efficacy (lm/w): 36.0
CCT: 2979
Cutoff: 50°

Single Unit Data		
Ceiling Height	Initial Footcandles	Beam Diameter
5'	80	2.0'
6'	55	2.4'
7'	41	2.8'
8'	31	3.2'
9'	25	3.6'

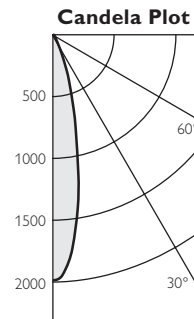

Candela Table		
Angle	Intensity	Lumens
0	1995	
5	1742	147
15	623	174
25	86	51
35	12	8
45	3	2
55	0	0
65	0	0

Job Information Type:

Calculite 1.75" Aperture, 400 Lumen LED

Reflector Finish Multipliers: CCD (1.0) WH (0.95) CCZ (0.88 (est.)) BK (tbd) CCD finish is tested. All other finishes calculated.

Fixture:	C2L04DL30K38R1	Single Unit Data		
Reflector:	C2LDLCCDP	Ceiling Height	Initial Footcandles	Beam Diameter
Accessory:	none			
Beam Angle:	38°	5'	37	3.0'
Spacing Ratio:	0.6	6'	26	3.6'
CBCP:	936	7'	19	4.2'
Lumens:	377	8'	15	4.8'
Watts:	10.8	9'	12	5.4'
Efficacy (lm/w):	34.9			
CCT:	2977			
Cutoff:	50°			

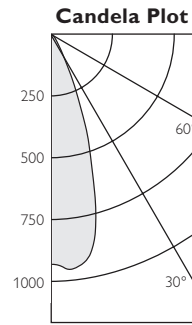

Candela Table		
Angle	Intensity	Lumens
0	936	
5	959	90
15	668	180
25	167	84
35	28	19
45	4	4
55	0	0
65	0	0

Fixture:	C2L04DL30K47R1	Single Unit Data		
Reflector:	C2LDLCCDP	Ceiling Height	Initial Footcandles	Beam Diameter
Accessory:	NONE			
Beam Angle:	47°	5'	22	3.5'
Spacing Ratio:	0.7	6'	15	4.2'
CBCP:	544	7'	11	4.9'
Lumens:	331	8'	9	5.6'
Watts:	11	9'	7	6.3'
Efficacy (lm/w):	30.0			
CCT:	2970			
Cutoff:	50°			

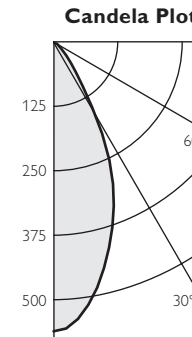

Candela Table		
Angle	Intensity	Lumens
0	544	
5	523	40
15	401	109
25	247	128
35	73	60
45	10	11
55	2	3
65	1	1

Fixture:	C2L04DL30K12R1	Single Unit Data		
Reflector:	C2LDLCCDP	Ceiling Height	Initial Footcandles	Beam Diameter
Accessory:	CA2DF2 (2° diffusion film)			
Beam Angle:	12°	5'	162	1.0'
Spacing Ratio:	0.2	6'	113	1.2'
CBCP:	4058	7'	83	1.4'
Lumens:	325	8'	63	1.6'
Watts:	10.7	9'	50	1.8'
Efficacy (lm/w):	30.4			
CCT:	2990			
Cutoff:	50°			

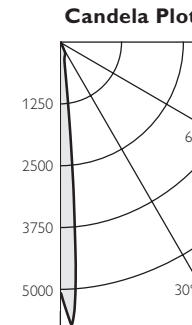

Candela Table		
Angle	Intensity	Lumens
0	4058	
5	2521	167
15	299	88
25	101	49
35	19	12
45	7	6
55	2	2
65	0	0

Job Information Type:

Calculite 1.75" Aperture, 400 Lumen LED

Reflector Finish Multipliers: CCD (1.0) WH (0.95) CCZ (0.88 (est.)) BK (tbd) CCD finish is tested. All other finishes calculated.

Fixture: C2L04DL30K12R1
Reflector: C2LDLCCDP
Accessory: CA2DF85
 (85° diffusion film)
Beam Angle: 66°
Spacing Ratio: 1.0
CBCP: 217
Lumens: 256
Watts: 10.7
Efficacy (lm/w): 23.9
CCT: 2990
Cutoff: 50°

Single Unit Data		
Ceiling Height	Initial Footcandles	Beam Diameter
5'	9	5.0'
6'	6	6.0'
7'	4	7.0'
8'	3	8.0'
9'	3	9.0'

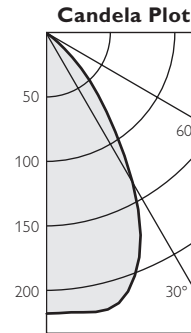

Candela Table		
Angle	Intensity	Lumens
0	217	
5	217	21
15	216	60
25	172	77
35	93	58
45	38	29
55	7	7
65	2	2

Fixture: C2L04DL30K12R1
Reflector: C2LDLCCDP
Accessory: CA2OPF (Opal
 warming/diffusion lens)
Beam Angle: 80°
Spacing Ratio: 1.1
CBCP: 133
Lumens: 190
Watts: 10.7
Efficacy (lm/w): 17.8
CCT: 2840
Cutoff: 50°

Single Unit Data		
Ceiling Height	Initial Footcandles	Beam Diameter
5'	5	5.5'
6'	4	6.6'
7'	3	7.7'
8'	2	8.8'
9'	2	9.9'

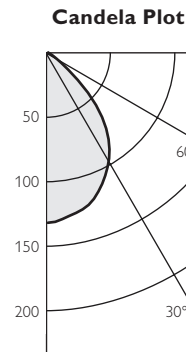

Candela Table		
Angle	Intensity	Lumens
0	133	
5	130	13
15	123	34
25	106	49
35	83	51
45	44	33
55	8	9
65	2	2

Fixture: C2L04DL30K17R1
Reflector: C2LDLLSCDP
 (integral linear diffusion lens)
Accessory: none
Beam Angle: 63° x 20°
Spacing Ratio: n/a
CBCP: n/a
Lumens: 314
Watts: 10.7
Efficacy (lm/w): 29.3
CCT: 2979
Cutoff: 75°

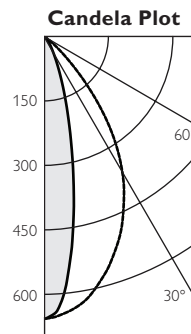

Candela Table			
Angle	"Intensity (Along)	Intensity (Across)	Lumens
0	660	660	
5	644	574	28
15	562	216	51
25	434	56	42
35	270	14	25
45	83	5	9
55	11	2	2
65	1	1	0

Job Information Type:

Calculite 1.75" Aperture, 400 Lumen LED

Reflector Finish Multipliers: CCD (1.0) WH (0.95) CCZ (0.88 (est.)) BK (tbd) CCD finish is tested. All other finishes calculated.

Fixture: C2L04DL30K17R1
Reflector: C2LLWCCDP
 (integral wall wash lens)
Accessory: none
Beam Angle: 66°
Spacing Ratio: 1.0
CBCP: 217
Lumens: 256
Watts: 10.7
Efficacy (lm/w): 23.9
CCT: 2990
Cutoff: 50°

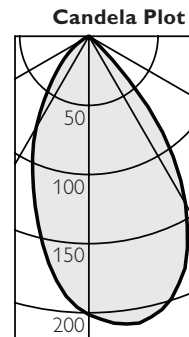

Candela Table

Angle	"Intensity	Intensity	Lumens
0	201	201	
5	189	208	9
15	141	205	21
25	96	169	24
35	56	106	19
45	29	24	11
55	12	2	5
65	3	1	1



Philips Lightolier
 e: lol.webmaster@philips.com
 t: (508) 679-8131
 w: www.lightolier.com

C2L04 May 11, 2012

Specifications are subject to change without notice.
 © Koninklijke Philips Electronics N.V., 2010. All rights reserved.

Job Information Type: